

PACCAR

Engine Aftertreatment Systems

Operator's Manual

2013 Emissions

Contents

Safety

1

Emergency

2

Controls

3

Driving

4

Maintenance

5

Information

6

Index

7

Contents

©2013 Paccar Inc - All Rights Reserved

This manual illustrates and describes the operation of features or equipment which may be either standard or optional on this vehicle. This manual may also include a description of features and equipment which are no longer available or were not ordered on this vehicle. Please disregard any illustrations or descriptions relating to features or equipment which are not on this vehicle.

PACCAR reserves the right to discontinue, change specifications, or change the design of its vehicles at any time without notice and without incurring any obligation.

The information contained in this manual is proprietary to PACCAR. Reproduction, in whole or in part, by any means is strictly prohibited without prior written authorization from PACCAR Inc.

Safety

About this Manual. 1-3
Safety Alerts 1-4
Illustrations. 1-6

Safety

About this Manual

Please take the time to get acquainted with your vehicle by reading this Operator's Manual. We recommend that you read and understand this manual from beginning to end before you operate your truck. This manual explains the safe, efficient operation and maintenance of your vehicle.

	NOTE
After you've read this manual, it should be stored in the cab for convenient reference and remain with this truck when sold.	

Your vehicle may not have all the features or options mentioned in this manual. Therefore, you should pay careful attention to the instructions that pertain to just your vehicle. In addition, if your vehicle is equipped

with special equipment or options not discussed in this manual, consult your dealer or the manufacturer of the equipment. All information contained in this manual is based on the latest production information available at the time of publication. PACCAR reserves the right to make changes at any time without notice.

Safety Alerts

Please read and follow all of the safety alerts contained in this manual. They are there for your protection and information. These alerts can help you avoid injury to yourself, your passengers, and help prevent costly damage to the vehicle. Safety alerts are highlighted by safety alert symbols and signal words such as "WARNING", "CAUTION", or "NOTE". Please do not ignore any of these alerts.

WARNING



The safety message following this symbol and signal word provides a warning against operating procedures which could cause injury or even death. They could also cause equipment or property damage. The alert will identify the hazard, how to avoid it, and the probable consequence of not avoiding the hazard.

Example:

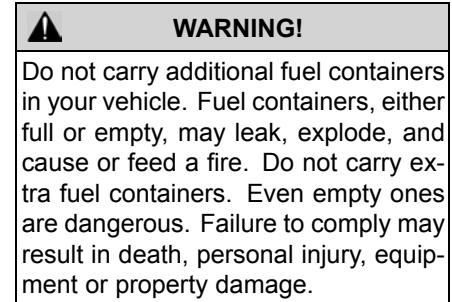

CAUTION

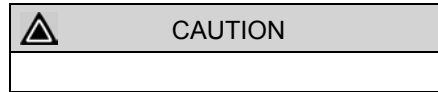

The safety alert following this symbol and signal word provides a caution against operating procedures which could cause equipment or property damage. The alert will identify the hazard, how to avoid it, and the probable consequence of not avoiding the hazard.

Example:

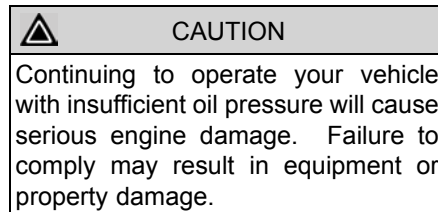

NOTE

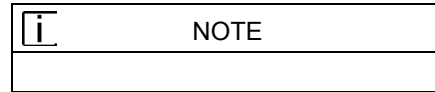

The alert following this symbol and signal word provides important information that is not safety related but should be followed. The alert will highlight things that may not be obvious and is useful to your efficient operation of the vehicle.

Example:

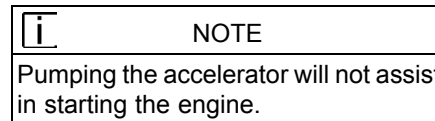

Illustrations

General Information

Some of the illustrations throughout this manual are generic and will not look exactly like the engine or parts used in your vehicle.

Aftertreatment System (ATS)

Introduction 3-3

Diesel Particulate Filter (DPF) System

Introduction 3-4

Controlling the Regeneration Process 3-4

Functionality / Notification Information 3-7

DPF Regeneration 3-13

Stop an Automatic or Parked Regeneration. 3-16

Idling in Freezing Temperatures. 3-17

Selective Catalytic Reduction (SCR) System

Introduction 3-18

Aftertreatment System (ATS)

Introduction

The Aftertreatment System (ATS) on your vehicle is made up of two systems:

1. Diesel Particulate Filter (DPF) System
2. Selective Catalytic Reduction (SCR) System

They fulfill two primary functions; particulate reduction & nitrogen oxide (NOx) reduction.

This section of the manual describes how to interact and control these two systems. For more detailed information about the aftertreatment process and its components, see INFORMATION on page 6-3.

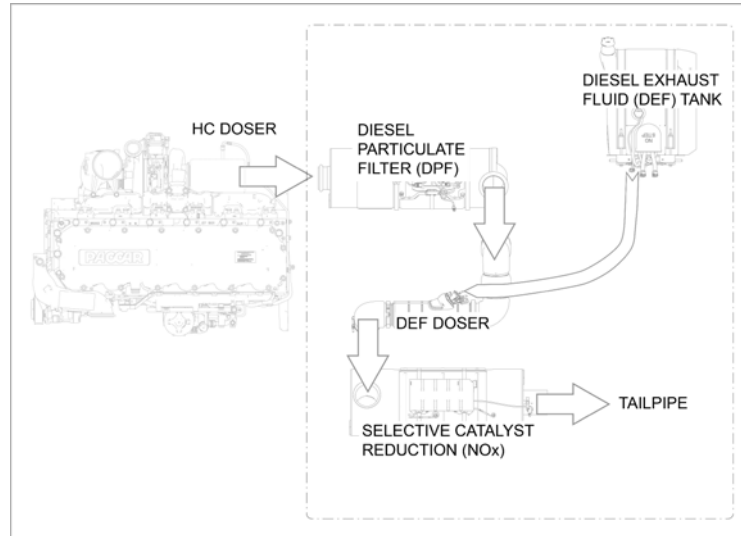

Diesel Particulate Filter (DPF) System

Diesel Particulate Filter (DPF) System

Introduction

The DPF system consists of a Hydrocarbon (HC) Doser (may not apply to all engines), a Diesel Oxidation Catalyst (DOC), and a DPF. The DPF filters soot out of the exhaust. When activated, the HC Doser sprays a small amount of diesel fuel (the HC) into the exhaust. The catalyst in the DOC reacts with the HC to generate heat. The heat is used to clean (regenerate) the DPF by reducing the trapped soot to ash.

Controlling the Regeneration Process

Your vehicle may be equipped with either a two or three position Regeneration Switch, mounted on the dash.

The three-position switch has a Disable mode allowing the driver to control the regeneration by overriding the ATS when certain operating conditions are not suitable for regeneration. Refer to Stop an Automatic or Parked Regeneration on page 3-16.

Vehicles with a two-position switch do not have a Disable mode, only start mode to manually initiate a Parked Regeneration.



WARNING!

If you operate in environments that contain explosive vapors or flammable materials, look to see if your vehicle's Regeneration Switch is equipped with a DISABLE function. The DISABLE function must be activated prior to entering the above environment(s) to prevent automatic engine regeneration from occurring, which could cause an explosion or fire. Failure to equip your vehicle with the proper switch (function) or failing to activate the DISABLE function before entering a combustible environment may cause an explosion or fire that could lead to death, personal injury, equipment or property damage.

i	NOTE
To obtain a Regeneration Switch with a DISABLE function, contact your nearest authorized PACCAR dealer to obtain the proper switch and reprogramming of your engine's ECU.	

Three-Position Regeneration Switch

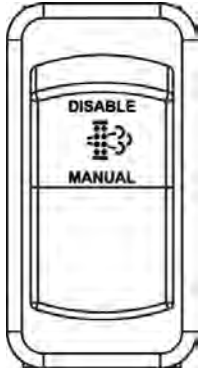

Regeneration Switch

Disable

When DISABLE is pressed, the system will not regenerate under any conditions.

⚠	CAUTION
Do not leave the switch in the DISABLE position unless you need to cancel or stop a regeneration. Running the engine with the switch in the DISABLE position will result in increased soot levels in the DPF and could eventually cause the engine to derate.	

Center

i	NOTE
During normal vehicle driving, the Regeneration Switch must be in the CENTER position.	

CENTER is the normal position of the switch. Unless you are manually initiating a Parked Regeneration or intentionally stopping a regeneration, the switch should be in this position. Placing the switch in the CENTER position will allow an Automatic

Diesel Particulate Filter (DPF) System

Regeneration to occur if conditions allow.

Manual Regeneration

Depressing the button in the MANUAL direction for at least 4 - 8 seconds will initiate a Parked Regeneration.

Two-Position Regeneration Switch

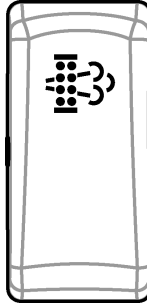

Two-Position Regeneration Switch

Start

Pressing the button for at least 4 - 8 seconds will initiate a Parked Regeneration.

Aftertreatment System Warning Lamps

ATS specific warning lamps and indicator symbols are located on the main gauge cluster.



Diesel Particulate Filter (DPF) Warning Lamp Symbol



High Exhaust System Temperature (HEST) Warning Lamp Symbol



Diesel Exhaust Fluid (DEF) Symbol



Malfunction Indicator Lamp (MIL) Symbol

	NOTE
Parked regeneration requires that your vehicle is stopped with the parking brake set. See Parked Regeneration on page 3-13 for details.	

Stop Engine Lamp

Illuminates and an audible alarm tone will sound when a major engine system problem exists. The vehicle will be equipped with of the following indicators:



Functionality / Notification Information

The ATS will regenerate the DPF by using hot exhaust gases normally generated by the engine. This typically occurs during highway operation (known as "Passive" Regeneration) and is transparent to the operation of the vehicle.



Occasionally, the exhaust gases are not hot enough for Passive Regeneration. When this occurs, the ATS will regenerate the DPF by increasing the exhaust temperature. This is referred to as an "Automatic" Regeneration and is also transparent to vehicle operation. An Automatic Regeneration event typically lasts 30 minutes. During and shortly after the event, the exhaust gases from the DPF may reach temperatures in excess of 650° C (1202° F). See the information in the following table on probable causes and recommended

actions related to the warning lamps and indicator symbols of the ATS.

The ATS may not be able to regenerate the DPF when the vehicle is driven at extended low speeds or with frequent starts and stops. In such cases, warning lamps and indicator symbols will alert the operator to take action. The operator should be aware of whether the lamps are on unaccompanied or in combination with others. The following table will describe each warning lamp(s) and what actions are needed from the operator.

Diesel Particulate Filter (DPF) System

Notification of High Exhaust System Temperature



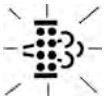

NOTIFICATION OF HIGH EXHAUST SYSTEM TEMPERATURE		
Warning Indicator	Condition	Operator Actions
 <p>HEST lamp on</p>	<p>Any one or combination of these conditions:</p> <ul style="list-style-type: none"> Exhaust outlet temperature is elevated above normal (at least 450° C / 842° F) and vehicle slows below 8 kph / 5 mph. Normal driving but engine is under heavy loading. Automatic Regeneration in process Parked Regeneration in process 	<p>Follow all warnings listed below. Use the DISABLE function of the Regeneration Switch if the situation requires. Follow the instructions described under Stop an Automatic or Parked Regeneration on page 3-16.</p>
 WARNING!		
<p>Temperature of the tail pipe, exhaust pipe, diesel particulate filter (DPF), selective catalytic reduction (SCR) device and surrounding components including enclosures and steps, will be elevated during and shortly after a regeneration event or normal vehicle operation when engine is under high or heavy loading. If the High Exhaust System Temperature (HEST) warning lamp is on:</p> <ul style="list-style-type: none"> Do not park in an area of combustible vapors or materials. You must keep combustibles at least 1.5 m (5 ft) away from the exhaust (outlet) stream (as it exits the tail pipe) while the HEST lamp is illuminated. Always park your vehicle outside. Failure to do so could ignite an explosion or harm bystanders which could result in serious injury. Do not park in an area where people are close by. You must keep combustibles at least 1.5 m (5 ft) away from the exhaust outlet while the HEST lamp is illuminated. Failure to do so could result in serious injury. Temperature of the tail pipe, exhaust pipes, diesel particulate filter (DPF), selective catalytic reduction (SCR) device and surrounding components including enclosures and steps becomes elevated during engine operation or any regeneration event and can cause serious burns to the skin. Allow adequate cooling time before approaching, working on or near any part of the exhaust system or surrounding components. 		

Notification Regeneration is Required



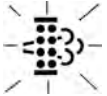

NOTIFICATION REGENERATION IS REQUIRED							
Warning Level	Warning Indicators	Condition	Operator Actions				
1	 DPF lamp on	The soot level in the DPF is above the desired level and requires regeneration.	The DPF requires regeneration soon. Follow the instructions described under DPF Regeneration on page 3-13.				
<table border="1" style="width: 100%; border-collapse: collapse;"> <tr> <td style="width: 5%; text-align: center; vertical-align: middle;">i</td> <td style="text-align: center; padding: 5px;">NOTE</td> </tr> <tr> <td colspan="2" style="padding: 5px;"> If you ignore the warning lamp and do not initiate regeneration at the soonest, safest possible time, the DPF will become increasingly clogged with soot and can lead to severe engine derate. </td> </tr> </table>				i	NOTE	If you ignore the warning lamp and do not initiate regeneration at the soonest, safest possible time, the DPF will become increasingly clogged with soot and can lead to severe engine derate.	
i	NOTE						
If you ignore the warning lamp and do not initiate regeneration at the soonest, safest possible time, the DPF will become increasingly clogged with soot and can lead to severe engine derate.							
2	 DPF lamp flashes	The soot level in the DPF continues to stay above the desired level and requires regeneration.	Regenerate the DPF as soon as safely possible. Follow the instructions described under DPF Regeneration on page 3-13.				
<table border="1" style="width: 100%; border-collapse: collapse;"> <tr> <td style="width: 5%; text-align: center; vertical-align: middle;">⚠</td> <td style="text-align: center; padding: 5px;">CAUTION</td> </tr> <tr> <td colspan="2" style="padding: 5px;"> If you do not initiate regeneration after the DPF warning lamp begins to flash, you only have a short time before the Check Engine lamp will illuminate and the engine will go into a protection mode and derate power. </td> </tr> </table>				⚠	CAUTION	If you do not initiate regeneration after the DPF warning lamp begins to flash, you only have a short time before the Check Engine lamp will illuminate and the engine will go into a protection mode and derate power.	
⚠	CAUTION						
If you do not initiate regeneration after the DPF warning lamp begins to flash, you only have a short time before the Check Engine lamp will illuminate and the engine will go into a protection mode and derate power.							

Diesel Particulate Filter (DPF) System

NOTIFICATION REGENERATION IS REQUIRED

Warning Level	Warning Indicators	Condition	Operator Actions
3	 <p>DPF lamp flashes</p>  <p>Check Engine lamp on</p>	<p>The soot level in the DPF continues to stay above the desired level and requires regeneration. The engine power will derate.</p>	<p>Regenerate the DPF immediately. Follow the instructions described under DPF Regeneration on page 3-13 for PACCAR MX engines, Parked Regeneration on page 3-13 for PACCAR PX and Cummins engines.</p> <div data-bbox="917 351 1494 399" style="border: 1px solid black; padding: 5px;"> <p> CAUTION</p> </div> <div data-bbox="917 404 1494 595" style="border: 1px solid black; padding: 5px;"> <p>If you do not initiate regeneration after the DPF warning lamp begins to flash and the Check Engine lamp is on, you only have a short time before the Stop Engine lamp will illuminate and the engine power will derate severely. No regeneration will be allowed at the next stage.</p> </div> <div data-bbox="917 622 1494 670" style="border: 1px solid black; padding: 5px;"> <p> NOTE</p> </div> <div data-bbox="917 675 1494 771" style="border: 1px solid black; padding: 5px;"> <p>Under some conditions after prolonged stationary idling, a Parked Regeneration may be required without a Level 1 or Level 2 warning.</p> </div>

Diesel Particulate Filter (DPF) System

NOTIFICATION REGENERATION IS REQUIRED			
Warning Level	Warning Indicators	Condition	Operator Actions
4	 DPF lamp flashes (MX engine only)	The soot level in the DPF is now at full capacity. Engine power derates (decrease rate depends on engine make)	At this point, you CANNOT regenerate the DPF. Tow your vehicle to an Authorized PACCAR Dealer to have the DPF removed. They will either have to clean it or replace it.
	 Check Engine lamp on (MX engine only)	<div style="border: 1px solid black; padding: 5px;">  <p style="text-align: center;">NOTE</p> The engine derate sequence is engine specific; therefore, to learn how this system works on your vehicle, refer to the Engine Manufacturer's Operation and Maintenance Manual supplied with your vehicle. </div>	<div style="border: 1px solid black; padding: 5px;">  <p style="text-align: center;">WARNING!</p> If the Stop Engine warning lamp illuminates, it means you have a serious engine system problem. This should be considered an emergency. You should stop the vehicle as safely as possible and turn OFF the ignition. The vehicle must be serviced and the problem corrected before driving again. Failure to comply may result in death, personal injury, equipment or property damage. </div>
	 Stop Engine lamp on Dash chime will sound		

Diesel Particulate Filter (DPF) System

Quick Reference Guide

Warning Symbols Quick Reference Guide

FOR INFORMATION



HEST
Hot Exhaust
Keep vehicle a safe distance from combustible items



DPF
Diesel Particulate Filter
Perform regeneration



DEF
Diesel Exhaust Fluid
Fill DEF tank if gauge reads low level. Otherwise seek service immediately for DEF fluid quality or DEF equipment repair.

SEEK SERVICE



CHECK ENGINE
Engine



MIL
Engine - Emissions



EMISSIONS SYSTEM
Emissions Related Engine Derate

- Perform stationary regeneration
- Add DEF fluid (more than 1/4 tank)
- Seek service at the next stop if the warning light is still on.

TAKE IMMEDIATE ACTION



COOLANT TEMP
Stop vehicle and idle engine



ENGINE OIL PRESSURE
Stop the engine or the engine may automatically shutdown.



STOP ENGINE
(May not apply for fire or emergency vehicle applications)

Any of the above icons may appear alone or together to alert of necessary action to be taken as soon as possible
Warnings may be either tell-tales or lights within the gauge associated with that fluid.
These lights will start flashing to notify of the upcoming engine derate.

DPF Regeneration

Carefully read the following instructions to regenerate the DPF. If you have any problems or difficulties contact your nearest authorized PACCAR dealer for assistance.

The ATS requires conditions typically found in highway driving to regenerate the DPF. If the DPF warning lamp is illuminated, the easiest option is to assist the ATS by proceeding to the nearest highway.

- Select a highway that has a posted legal speed of more than 56 kph (35 mph).
- Drive your vehicle until the DPF lamp goes off. This may take 30 - 45 minutes of speeds greater than 32 kph (20 mph).

If your operation or planned route in the immediate future limits your ability to reach highway speeds, proceed

to the next section titled Parked Regeneration.

Parked Regeneration

In very limited applications or operations the DPF must be regenerated by initiating a Parked Regeneration. Follow these seven steps to initiate a Parked Regeneration:

1. Pull the vehicle over to a safe location.
2. Ensure no one is in the immediate vicinity of the tail pipe.
3. Maintain a minimum of 1.5 m (5 ft) of clearance to any combustible materials from the edge and top of the vehicle.

Diesel Particulate Filter (DPF) System

3

 WARNING!
Parking the vehicle too close to any combustible materials or vapors may start a fire, ignite an explosion or burn someone standing close by. Before pushing the Regeneration Switch on the dash, walk around your vehicle and ensure you have at least 1.5 m (5 ft) clearance from the sides and top of your vehicle to any combustibles. Ensure no one is in the immediate vicinity of the tail pipe. Failure to comply could ignite a fire or cause an explosion, resulting in death, personal injury, equipment or property damage.

 WARNING!
Never initiate a regeneration in a closed building or enclosure. Always park your vehicle outside and ensure no one is in the immediate vicinity. Failure to comply could ignite a fire or cause an explosion, resulting in death, personal injury, equipment or property damage.

 NOTE
Typical operation areas or materials that can contain explosive vapors, flammable materials or people in close proximity of the vehicle are:
<ul style="list-style-type: none">• Fuel depots• Grain elevators• Dry grass, leaves or trees• Transfer refuse stations/dumps• Parking lots• Load/unload terminals

 NOTE
While the list above may appear comprehensive, it is your responsibility to take the necessary precautions and be aware of your surroundings and ensure that no combustibles (materials or vapors) or bystanders are close by before initiating a regeneration.

4. Verify that the following conditions are met before proceeding. A Parked Regeneration will not initiate if any of these conditions are not met:
- Parking brake is applied / set
 - Engine is at low idle
 - DPF warning lamp is illuminated or flashing
 - Coolant is at operating temperature
 - No throttle
 - PTO is disengaged
 - Transmission is in neutral
 - Cruise control switch is off
5. Get out and walk all around vehicle to ensure that the vehicle is at least 1.5 m (5 ft) away from all

combustible materials and no one is in the immediate vicinity.

6. Climb back into the vehicle.
7. Push the regeneration button in the direction for MANUAL as indicated on the switch for at least 4 - 8 seconds to initiate a Parked Regeneration.
- After regeneration starts if any of the conditions (in step 4) change or become activated regeneration will automatically shut off.

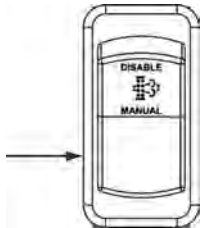

Regeneration Switch

i	NOTE
Acknowledgment that a Parked Regeneration has initiated will vary by engine. The most predominant acknowledgment to you will be an increase in engine RPM and overall engine noise.	

i	NOTE
A Parked Regeneration may take 30 or more seconds to initiate as the ATS system conducts various self-checks to verify all the system requirements have been met.	

If you are unable to initiate a Parked Regeneration and the DPF warning lamp is illuminated, contact your nearest PACCAR dealer for assistance.

Diesel Particulate Filter (DPF) System

Stop an Automatic or Parked Regeneration



NOTE

The information in this section only applies to vehicles equipped with a three-position Engine Regeneration Switch.

3

If an Automatic or Parked Regeneration is in process and you want the regeneration to stop, OR you want to prevent a regeneration from occurring, your vehicle is equipped with a switch that can stop an Automatic or Parked Regeneration. Since Automatic Regenerations can occur at any time, you must depress the DISABLE portion of the Regeneration Switch ANYTIME you plan to drive your vehicle into a building, enclosure or area where the activation of a regeneration is not allowed. If the regeneration does not stop, turn the vehicle ignition OFF.



WARNING!

Never allow an Automatic Regeneration to automatically occur while inside a building such as a service bay, shop or building of any kind. Anytime you are parking your vehicle inside a building or enclosure, ALWAYS press the Regeneration (DISABLE) Switch prior to entering the building. Failure to comply could ignite a fire or cause an explosion, resulting in death, personal injury, equipment or property damage.



WARNING!

Never initiate a Parked Regeneration in a closed building or enclosure. Always park your vehicle outside. Failure to comply could ignite a fire or cause an explosion, resulting in death, personal injury, equipment or property damage.



WARNING!

If you operate in environments that contain explosive vapors or flammable materials, look to see if your vehicle's Regeneration Switch is equipped with a DISABLE function. The DISABLE function must be activated prior to entering the above environment(s) to prevent automatic engine regeneration from occurring, which could cause an explosion or fire. Failure to equip your vehicle with the proper switch (function) or failing to activate the DISABLE function before entering a combustible environment may cause an explosion or fire that could lead to death, personal injury, equipment or property damage.

	NOTE
To obtain a Regeneration Switch with a DISABLE function, contact an authorized PACCAR dealer to obtain the proper switch and reprogramming of your engine's ECU.	

Idling in Freezing Temperatures

Idling the engine for 3 or more hours in freezing temperatures causes the build up of soot and moisture in the DPF. Extra heat is required to oxidize the soot and moisture by using the following methods:

- **DPF Regeneration:**
If the DPF Lamp turns on, follow the instructions described under DPF Regeneration on page 3-13.

	NOTE
If you ignore the warning lamp and do not initiate regeneration at the soonest, safest possible time, the DPF will become increasingly clogged with soot and can lead to engine shutdown.	

- **PACCAR PX-7 and PX-9 Engines and Cummins ISL Engine:**
Regardless if the DPF lamp is on or off, the engine speed will automatically increase to 1000 to 1100 RPM and remain at this speed for 10 minutes to perform an automated DPF cleaning. If necessary, the RPMs can be lowered by depressing the throttle, clutch, or brake pedal. If the engine continues to idle, the aftertreatment system will try again to raise the idle speed until the aftertreatment temperatures are suitable.

Selective Catalytic Reduction (SCR) System

Selective Catalytic Reduction (SCR) System

Introduction

The SCR system consists of a Diesel Exhaust Fluid (DEF) Doser and a SCR Catalyst. The DEF Doser sprays a small amount of DEF into the exhaust. The SCR Catalyst reacts with the DEF to break down the Nitrogen Oxides (NOx) in the exhaust into nitrogen and water vapor.

Diesel Exhaust Fluid (DEF) Gauge

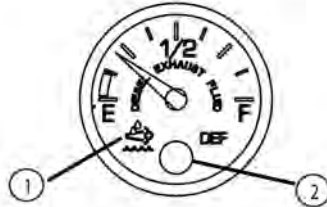

- 1  DEF Symbol
- 2  DEF Warning Lamp

DEF is consumable and needs to be replenished, so monitor the DEF level gauge as you would the fuel level gauge.

The DEF warning lamp will illuminate for the following 3 reasons:

1. DEF Level Warning: To warn you to refill the DEF tank. The warning lamp will turn on when the gauge needle is near or in the red zone. There are 4 stages to this warning.

 CAUTION	
If the DEF warning lamp turns on due to the DEF level, refill the DEF tank. Failure to refill may cause the engine to derate and limit vehicle speed.	

2. DEF Quality: The engine detects that DEF quality is below acceptable levels. The gauge needle is in the upper region, indicating there is fluid, but the quality is poor. There are 3 stages to these warnings.

Selective Catalytic Reduction (SCR) System

 CAUTION
If the DEF warning lamp turns on due to DEF Quality, see Contamination/Incorrect Fluid for corrective action. Failure to correct may cause the engine to derate and limit vehicle speed.

detects failures that may be the result of tampering with the SCR system. The gauge needle is in the upper region, indicating there is fluid, but system failure is detected. There are 3 stages to this warning.

 CAUTION
If the DEF warning lamp turns on due to System Tampering, see your authorized PACCAR dealer to have this repaired. Failure to repair the system may cause the engine to derate and limit vehicle speed.







3. SCR System Tampering: To warn you when the engine system

System Status	Non-Emergency Vehicles	Emergency Vehicles
DEF Level Warning	See table on page 3-20.	See table on page 3-26.
DEF Quality	See table on page 3-22.	See table on page 3-27.
SCR System Tampering	See table on page 3-24.	See table on page 3-29.

Selective Catalytic Reduction (SCR) System





DEF Level Warning – Non-Emergency Vehicles

DEF LEVEL WARNING – NON-EMERGENCY VEHICLES

Warning Level	Warnings Indicators	Condition	Effect on Engine
0	None	DEF Level sufficient	None
1	 DEF Warning Lamp on	DEF Level fallen below initial warning	None
2	 DEF Warning Lamp flashing	DEF Level fallen below initial warning	None
3	  DEF Warning Lamp flashing Check Engine Lamp on	DEF Level fallen below initial warning	Engine power derated 25%
4	  DEF Warning Lamp flashing Check Engine Lamp on	DEF Level empty	Engine power derated 40%













3

Selective Catalytic Reduction (SCR) System



DEF LEVEL WARNING – NON-EMERGENCY VEHICLES						
Warning Level	Warnings Indicators			Condition	Effect on Engine	
Final	 DEF Warning Lamp flashing	 Check Engine Lamp on	 MIL may be on	 Stop Engine Lamp may be on	Engine has been shut down, idled for 1-hour or a fuel re-fill has occurred	Engine power derated and/or vehicle speed significantly limited
	<p>NOTE</p> <p>The Malfunction Indicator Lamp (MIL) will illuminate if the OBD (Onboard Diagnostics) system detects a possible emissions system failure.</p>					

Selective Catalytic Reduction (SCR) System

DEF Quality – Non-Emergency Vehicles









DEF QUALITY – NON-EMERGENCY VEHICLES						
Warning Level	Warnings Indicators			Condition	Effect on Engine	
0	None			No Quality Issue	None	
1	 DEF Warning Lamp on (MX engine only)	 Check Engine Lamp on	 MIL may be on	Quality Issue Detected	None	
2	 DEF Warning Lamp flashing (MX engine only)	 Check Engine Lamp on	 MIL may be on	128 km (50 mi) or 1 hour After Detected	Engine power derated 25%	
3	 DEF Warning Lamp flashing (MX engine only)	 Check Engine Lamp on	 MIL may be on	241 km (150 mi) or 3 hours After Detected	Engine power derated 40%	
Final	 DEF Warning Lamp flashing (MX engine only)	 Check Engine Lamp on	 MIL may be on	 Stop Engine Lamp may be on	Engine has been shut down, idled for 1-hour or a fuel re-fill has occurred	Engine power derated and/or vehicle speed significantly limited

Selective Catalytic Reduction (SCR) System

DEF QUALITY – NON-EMERGENCY VEHICLES			
Warning Level	Warnings Indicators	Condition	Effect on Engine
System may not perform a DEF quality check at 8 kph (5 mph) operation from reduced operating temperatures. A service tool may be required to temporarily remove the 8 kph (5 mph) inducement and allow the system to run at temperatures where the DEF quality can be checked			
	 NOTE		
	The Malfunction Indicator Lamp (MIL) will illuminate if the OBD (Onboard Diagnostics) system detects a possible emissions system failure.		





Selective Catalytic Reduction (SCR) System

SCR Component Failure – Non-Emergency Vehicles

SCR COMPONENT FAILURE – NON-EMERGENCY VEHICLES					
Warning Level	Warnings Indicators		Condition	Effect on Engine	
0	None		No Issue	None	
1	 DEF Warning Lamp on (MX engine only)	 Check Engine Lamp on	 MIL may be on	Failure Detected	None
2	 DEF Warning Lamp flashing (MX engine only)	 Check Engine Lamp on	 MIL may be on	128 km (50 mi) or 1 hour After Detected	Engine power derated 25%
3	 DEF Warning Lamp flashing (MX engine only)	 Check Engine Lamp on	 MIL may be on	322 km (200 mi) or 4 hours After Detected	Engine power derated 40%











3

Selective Catalytic Reduction (SCR) System

SCR COMPONENT FAILURE – NON-EMERGENCY VEHICLES						
Warning Level	Warnings Indicators			Condition	Effect on Engine	
Final	 DEF Warning Lamp flashing (MX engine only)	 Check Engine Lamp on	 MIL may be on	 Stop Engine Lamp may be on	Engine has been shut down, idled for 1-hour or a fuel re-fill has occurred	Engine power derated and/or vehicle speed reduced to 8 kph (5 mph)
	<div style="border: 1px solid black; padding: 5px;"> <div style="display: flex; align-items: center;"> <div style="border: 1px solid black; padding: 2px; margin-right: 10px;">i</div> <div>NOTE</div> </div> <p>The Malfunction Indicator Lamp (MIL) will illuminate if the OBD (Onboard Diagnostics) system detects a possible emissions system failure.</p> </div>					

Selective Catalytic Reduction (SCR) System











DEF Level Warning – Emergency Vehicles

DEF LEVEL WARNING – EMERGENCY VEHICLES				
Warning Level	Warnings Indicators		Condition	Effect on Engine
0	None		DEF Level Sufficient	None
1	 DEF Warning Lamp on		DEF Level fallen below initial warning	None
2	 DEF Warning Lamp flashing	 Check Engine Lamp on	DEF Level fallen below critical warning	None
3	 DEF Warning Lamp flashing	 Check Engine Lamp on	DEF Level less than 5%	Vehicle speed limited to 88 kph (55 mph)
Final	 DEF Warning Lamp flashing	 Check Engine Lamp on	 MIL may be on  Stop Engine Lamp may be on	DEF Level empty and vehicle has been shut down or stationary for 1-hour Vehicle speed limited to 40 kph (25 mph)
	NOTE The Malfunction Indicator Lamp (MIL) will illuminate if the OBD (Onboard Diagnostics) system detects a possible emissions system failure.			



3

Selective Catalytic Reduction (SCR) System

DEF Quality – Emergency Vehicles

DEF QUALITY – EMERGENCY VEHICLES						
Warning Level	Warnings Indicators			Condition	Effect on Engine	
0	None			No DEF Quality Issue	None	
1	 DEF Warning Lamp on (MX engine only)	 Check Engine Lamp on (Not on ISX Engine)	 MIL may be on	Quality Issue Detected	None	
2	 DEF Warning Lamp flashing (MX engine only)	 Check Engine Lamp on	 MIL may be on	10-hours After Detected	Vehicle speed limited to 88 kph (55 mph)	
Final	 DEF Warning Lamp flashing (MX engine only)	 Check Engine Lamp on	 MIL may be on	 Stop Engine Lamp may be on	20-hours after detected, engine has been shut down or idled for 1-hour	Vehicle speed limited to 40 kph (25 mph)













Selective Catalytic Reduction (SCR) System

DEF QUALITY – EMERGENCY VEHICLES			
Warning Level	Warnings Indicators	Condition	Effect on Engine
System may not perform a DEF quality check at 8 kph (5 mph) operation from reduced operating temperatures. A service tool may be required to temporarily remove the 8 kph (5 mph) inducement and allow the system to run at temperatures where the DEF quality can be checked			
	 NOTE		
	The Malfunction Indicator Lamp (MIL) will illuminate if the OBD (Onboard Diagnostics) system detects a possible emissions system failure.		

3

Selective Catalytic Reduction (SCR) System

SCR Component Failure – Emergency Vehicles

SCR COMPONENT FAILURE – EMERGENCY VEHICLES						
Warning Level	Warnings Indicators			Condition	Effect on Engine	
0	None			No Issue	None	
1	 DEF Warning Lamp on (MX engine only)	 Check Engine Lamp on	 MIL may be on	Failure Detected	None	
2	 DEF Warning Lamp flashing (MX engine only)	 Check Engine Lamp on	 MIL may be on	10-hours After Detected	Vehicle speed limited to 88 kph (55 mph)	
Final	 DEF Warning Lamp flashing (MX engine only)	 Check Engine Lamp on	 MIL may be on	 Stop Engine Lamp may be on	40-hours after detected, engine has been shut down or idled for 1-hour	Vehicle speed limited to 40 kph (25 mph)
	 NOTE The Malfunction Indicator Lamp (MIL) will illuminate if the OBD (Onboard Diagnostics) system detects a possible emissions system failure.					

Diesel Exhaust Fluid (DEF) Tank Straps 5-3

Diesel Exhaust Fluid (DEF) Tank Straps

During normal operation of the truck, the DEF tank straps may relax. Inspect the spring on top of the strap. If more than $\frac{1}{2}$ " (12.7mm) of the spring is exposed, the bolt will need to be re-torqued between 70 – 80 in-lbs. (7.9 – 9 Nm). This distance is measured from the washer at the end of the spring to the edge of the tube at the top of the straps.

See Engine Operator's Manual for filter maintenance interval

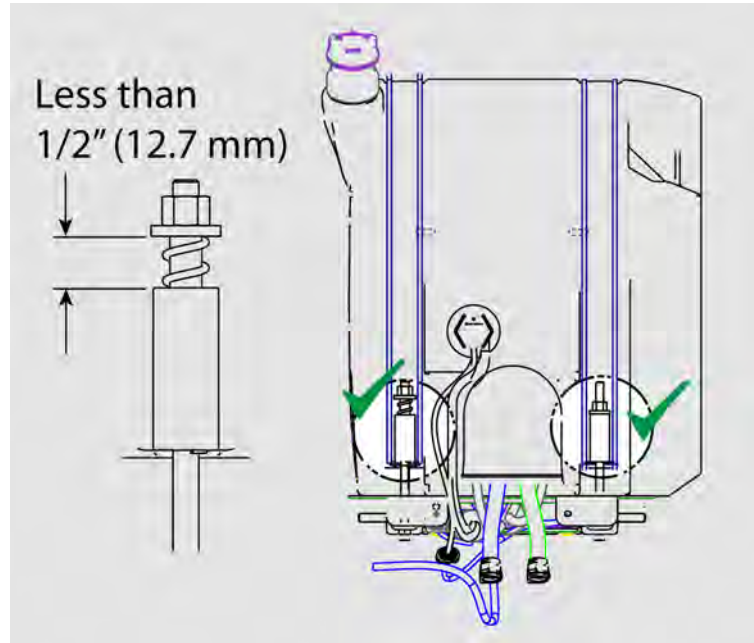

Information

Introduction 6-3
Tampering with Aftertreatment System 6-4

Diesel Particulate Filter (DPF) System

Overview 6-5

Selective Catalytic Reduction (SCR) System

Overview 6-7
Diesel Exhaust Fluid (DEF) Recommendations and
Specifications 6-8
Storage 6-10
Handling 6-11
Disposal 6-11
Contamination/Incorrect Fluid. 6-12
Freezing 6-12

Information

Introduction

The Aftertreatment System (ATS) on your vehicle is made up of two systems:

1. Diesel Particulate Filter (DPF) System
2. Selective Catalytic Reduction (SCR) System

They fulfill two primary functions: particulate reduction & nitrogen oxide (NOx) reduction.

This section of the manual provides more detailed information about the aftertreatment process and its components.

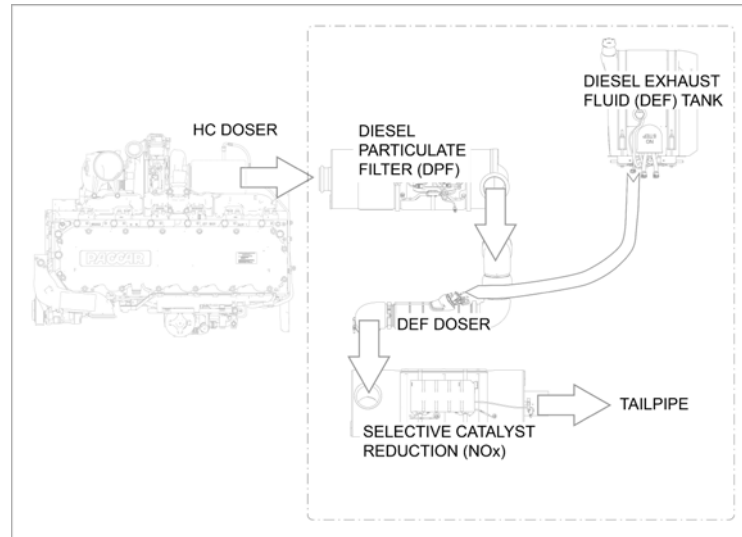

Tampering with Aftertreatment System

The aftertreatment system for your vehicle as installed from the factory was specifically designed to meet the emissions requirements of the US Environmental Protection Agency and California Air Resources Board. Any changes of component locations or modifications of any aftertreatment system components may reduce the emission effectiveness and you may be subject to fines under the United States Clean Air Act.

Diesel Particulate Filter (DPF) System

Overview

The DPF system consists of a Hydrocarbon (HC) Doser (may not apply to all engines), a Diesel Oxidation Catalyst (DOC), and a DPF.

The components of the DPF system perform the following functions:

- The ATS inlet and outlet adapt the vehicle exhaust piping to the ATS, and also provide a mounting location for the aftertreatment gas temperature sensors.
- The DPF differential pressure sensor measures the restriction across the DPF.
- The DPF filters soot out of the exhaust.

- When activated, the HC Doser sprays a small amount of diesel fuel (the HC) into the exhaust. The catalyst in the DOC reacts with the HC to generate heat. The heat is used to clean (regenerate) the DPF by reducing the trapped soot to ash.
- Soot is composed of the partially burned particles of fuel that occur during normal engine operation (black smoke).
- Over time, both soot and ash accumulate in the DPF and must be removed. Soot is removed by a process called regeneration. Ash is removed by removing the DPF and cleaning it at specified intervals.
- A vehicle with a DPF has up to two additional indicator lamps on the dashboard. The two additional lamps, along with the check

engine lamp, alert the operator of the status of the DPF.

Diesel Particulate Filter (DPF) System



CAUTION

Do not submerge or allow water to enter the DPF assembly. Components of the assembly can be damaged and affect the performance of the aftertreatment system. Failure to comply may result in equipment or property damage.



NOTE

Refer to your engine manufacturer's Operator's Manual for diesel particulate filter (DPF) maintenance information.



NOTE

Refer to your vehicle or engine manufacturer's Operator's Manual for additional information on the engine indicator lamps.



NOTE

Ultra low sulfur diesel (ULSD) fuel is required for engines equipped with an aftertreatment diesel particulate filter. If ULSD is not used, the engine may not meet emissions regulations, and the DPF or aftertreatment Diesel Oxidation Catalyst (DOC) can be damaged.

Selective Catalytic Reduction (SCR) System

Overview

The SCR system is composed of several main components:

1. Diesel Exhaust Fluid (DEF) Controller
2. DEF Dosing Unit (DEF Module)
3. DEF Dosing Valve
4. SCR Catalyst

i	NOTE
It is unlawful to tamper with, modify, or remove any component of the SCR system. It is also unlawful to use DEF that does not meet the specifications provided or to operate the vehicle/equipment with no DEF.	

DEF is required for an engine equipped with a SCR system. DEF is a fluid that

is sprayed into the exhaust gas prior to the SCR catalyst. The DEF vaporizes and decomposes to form carbon dioxide and ammonia. The ammonia reacts with the NO_x emissions over the aftertreatment SCR catalyst to form nitrogen and water.

DEF:

- may have a slight ammonia smell
- is colorless
- is non-toxic and non-polluting
- is non-flammable

Selective Catalytic Reduction (SCR) System

Diesel Exhaust Fluid (DEF) Recommendations and Specifications

WARNING!

It is unlawful to tamper with or remove any component of the aftertreatment system. It is also unlawful to use a Diesel Exhaust Fluid (DEF) that does not meet the specifications provided or to operate the vehicle/equipment without Diesel Exhaust Fluid (DEF).

WARNING!

Diesel Exhaust Fluid (DEF) contains urea. Do not get the substance in your eyes. In case of contact, immediately flush eyes with large amounts of water for a minimum of 15 minutes. Do not swallow internally. In the event the diesel exhaust fluid is ingested, contact a physician immediately. Reference the Materials Safety Data Sheet (MSDS) for additional information.

CAUTION

Never attempt to create Diesel Exhaust Fluid (DEF) by mixing agricultural grade urea with water. Agricultural grade urea does not meet the necessary specifications required and the aftertreatment system may be damaged.

CAUTION

PACCAR Inc requires the use of DEF meeting ISO 22241-1 (DIN 70070) specifications. There is NO acceptable substitute. Failure to use the correct DEF may cause engine damage and/or void the warranty.

Selective Catalytic Reduction (SCR) System

i	NOTE
Some locations may reference the DIN 70070 standard. DEF specification limits of this standard are identical to ISO 22241-1.	

PACCAR Inc is not responsible for failures or damage resulting from what PACCAR Inc determines to be abuse or neglect, including but not limited to: operation without correctly specified DEF; lack of maintenance of aftertreatment; improper storage, or shutdown practices; unauthorized modifications of the engine and aftertreatment. PACCAR is also not responsible for failures caused by incorrect DEF or by water, dirt or other contaminants in the DEF. Refer to your engine and vehicle operator's manuals for maintenance, storage, and shutdown information.

For engines using SCR operating in the United States and Canada, it is recommended that the DEF used be certified by the American Petroleum Institute (API).

i	NOTE
To ensure the correct DEF is used, PACCAR Inc recommends the use of TRP® CleanBlue Diesel Exhaust Fluid which is available in different quantity options from small to bulk containers.	



- DEF is readily available at truck stops and at all PACCAR Engine dealers. For assistance locating DEF, contact your local PACCAR authorized repair location.
- If your vehicle is out of DEF and you are unable to locate a source to purchase DEF, please contact the vehicle OEM customer care center at the telephone number provided in the vehicle operator's manual. The vehicle OEM customer care center will be able to contact the nearest dealer location to you and arrange for an emergency shipment of DEF to your location 24 hours a day.

Selective Catalytic Reduction (SCR) System

The following are other common names used for Diesel Exhaust Fluid (DEF):

- AUS 32 (Aqueous Urea Solution 32)
- AdBlue
- NOx Reduction Agent
- Catalyst Solution

Regardless of what the DEF is called, the DEF must meet the ISO 22241-1 (DIN 70070) specifications.

Storage

i	NOTE
The following information is for reference and is to be used as a guideline only. There are many factors that determine Diesel Exhaust Fluid (DEF) shelf life, with temperature and duration being two of the major determining contributors. If in doubt, replace the fluid with known quality DEF. DEF has a limited shelf life, both in the vehicle's diesel exhaust fluid tank and in storage/bulk/transportation containers.	

The following conditions are ideal for maintaining DEF quality and shelf life during prolonged transportation and storage:

- Storage temperature between -5°C and 25°C (23°F and 77°F)
- Storage in sealed containers to avoid contamination

- Avoidance of direct sunlight

In these conditions, Diesel Exhaust Fluid (DEF) has a minimum expected shelf life of 18 months. If stored at higher temperatures for extended periods of time, the shelf life will be reduced by approximately 6 months for every 5°C (9°F) above the highest storage temperature listed above. Long term storage in a vehicle (in excess of 6 months) is not recommended.

i	NOTE
To assist in preventing DEF from deteriorating when stored in the vehicle's DEF tank, locate and plug the tank's venting to seal the tank exposure to the atmosphere.	

Handling

 CAUTION
If Diesel Exhaust Fluid (DEF) is spilled on metal surfaces (for example the steps, fuel tanks or grab handles) rinse and clean immediately with water. Failure to do so may leave permanent corrosive stains on the metal surfaces which can not be removed.

- Make sure to only use approved containers to transport and store DEF. Containers made of polyethylene and polypropylene are recommended.
- If DEF is spilled, rinse and clean immediately with water.
- Avoid prolonged contact with skin. In case of contact, wash with immediately with soap and water. If not washed immediately, a white film will be left when the DEF dries

that can be more difficult to wash off.

 NOTE
Spilled DEF, if left to dry or wiped away with a cloth only, will leave a white residue. Failure to clean the spilled DEF may result in an incorrectly diagnosed leak of the DEF Dosing system.

Before using containers, funnels, etc. that will be used to dispense, handle or store DEF, make sure to wash thoroughly to remove any contaminants and then rinse with distilled water.

 NOTE
Do not use tap water to rinse components that will be used to deliver diesel exhaust fluid. Tap water will contaminate the DEF. If distilled water is not available, rinse with tap water and then rinse with DEF.

Disposal

If disposing Diesel Exhaust Fluid (DEF), always check with the local authority regulations on proper disposal process and requirements.

Selective Catalytic Reduction (SCR) System

Contamination/Incorrect Fluid



CAUTION

Never add water or any other fluid besides what is specified to the DEF tank. The aftertreatment system may be damaged.

In the event that the incorrect fluid is added to the Diesel Exhaust Fluid tank, such as, but not limited to:

- Water
- Diesel Fuel
- Hydraulic Fluid
- Coolant
- Windshield Washer Fluid

Contact a local PACCAR Authorized Repair location to determine the appropriate repair direction. If only water has been added to the DEF tank,

drain the DEF tank, flush with distilled water and refill with new and/or known good DEF.

Freezing



CAUTION

The Diesel Exhaust Fluid (DEF) system purges to prevent damage from freezing. If your vehicle is equipped with battery disconnect switches, do NOT disconnect battery power within two minutes of switching the ignition key off. Failure to comply may result in vehicle or property damage.



CAUTION

Do NOT add any chemicals/additives to the Diesel Exhaust Fluid (DEF) in an effort to prevent freezing. If chemicals/additives are added to the DEF, the aftertreatment system may be damaged.

DEF will freeze around -12°C (11°F). The DEF system on the vehicle is designed to accommodate this and does not require any intervention.

Index

- A**
- About this Manual..... 1-3
 - Aftertreatment Information
 - aftertreatment inlet and outlet 6-5
 - alternate DEF names 6-10
 - contamination or incorrect fluid 6-12
 - DEF controller 6-7
 - DEF dosing unit 6-7
 - DEF dosing valve 6-7
 - DEF Module 6-7
 - diesel oxidation catalyst 6-5
 - diesel particulate filter..... 6-5
 - diesel particulate filter (DPF)
 - differential pressure sensor . 6-5
 - freezing..... 6-12
 - indicator lamps 6-5
 - recommendations and
 - specifications 6-8
 - regeneration 6-5
 - SCR catalyst..... 6-7
 - selective catalytic reduction (SCR) 6-7
 - soot..... 6-5
 - storage, handling and disposal... 6-8
 - ultra low sulfur diesel (ULSD)
 - fuel 6-6
 - Aftertreatment System (ATS) 6-3
 - diesel particulate filter (DPF)
 - system 3-4-6-5
 - Aftertreatment System Description
 - DPF regeneration 3-13
 - functionality / notification
 - information..... 3-7
 - high exhaust system
 - temperature..... 3-8
 - notification regeneration is
 - required 3-9
 - parked regeneration..... 3-13
 - regeneration (MANUAL) switch 3-15
 - stopping an automatic or parked
 - regeneration 3-16
 - Aftertreatment System Tampering.. 6-4
 - Aftertreatment System Warning
 - Lamps 3-6
 - diesel particulate filter (DPF) warning
 - lamp symbol 3-6
 - high exhaust system temperature
 - (HEST) warning lamp
 - symbol 3-6
 - Automatic Regeneration..... 3-4-3-5, 3-7, 3-16
- C**
- Caution..... 1-5
 - Cleaning 3-4-6-5
 - Consumer information..... 6-3
 - Contamination/Incorrect Fluid 6-12
 - Controlling the Regeneration
 - Process..... 3-4
 - regeneration switch
 - (three-position) 3-5

Index

regeneration switch
(two-position)3-6
warning lamps3-6
Controls
aftertreatment system (ATS)3-3
controlling the regeneration
process.....3-4
DEF level warning table –
emergency vehicles..... 3-26
DEF level warning table –
non-emergency vehicles .. 3-20
DEF quality – emergency
vehicles 3-27
DEF quality – non-emergency
vehicles 3-22
diesel particulate filter (DPF)
system3-4
DPF regeneration 3-13
functionality / notification
information.....3-7
high exhaust system
temperature.....3-8
notification regeneration is
required3-9
parked regeneration..... 3-13
regeneration (MANUAL) switch 3-15

regeneration switch
(three-position)3-5
regeneration switch
(two-position)3-6
SCR component failure – emergency
vehicles 3-29
SCR component failure –
non-emergency vehicles .. 3-24
SCR system 3-18
stopping an automatic or parked
regeneration 3-16
three-position regeneration
switch3-4
warning lamps3-6

D

DEF Gauge..... 3-18
DEF Level Warning Table – Emergency
Vehicles..... 3-26
DEF Level Warning Table –
Non-Emergency Vehicles 3-20
DEF Quality – Emergency
Vehicles..... 3-27
DEF Quality – Non-Emergency
Vehicles..... 3-22

DEF tank straps.....5-3
Diesel Exhaust Fluid
alternate DEF names 6-10
contamination or incorrect fluid 6-12
disposal 6-11
freezing..... 6-12
handling 6-11
recommendations and
specifications 6-8
storage 6-10
Diesel Exhaust Fluid (DEF)
Gauge 3-18
Diesel Exhaust Fluid (DEF)
Recommendations and
Specifications 6-8
Diesel Exhaust Fluid (DEF) Symbol 3-6
Diesel Exhaust Fluid (DEF) Tank
Straps.....5-3
Diesel Particulate Filter (DPF)
System..... 3-3–6-5
diesel oxidation catalyst (DOC) .. 3-4
DPF..... 3-4
hydrocarbon (HC) doser 3-4
Diesel Particulate Filter (DPF) Warning
Lamp Symbol 3-6
Disposal

diesel exhaust fluid..... 6-11
 Doser..... 3-4–6-5, 3-18
 DPF Regeneration 3-13

F

Freezing 6-12
 Functionality / Notification
 Information 3-7

G

Gauge
 DEF..... 3-18
 General Information 1-6

H

Handling
 diesel exhaust fluid..... 6-11
 High Exhaust System Temperature
 (HEST) Warning Lamp Symbol 3-6
 High Exhaust System Temperature
 Notification 3-8
 Hydrocarbon (HC) 3-4–6-5

I

Idle 3-10, 3-17
 Idling in Freezing Temperatures .. 3-17
 Illustrations 1-6
 Information
 aftertreatment description 6-3

M

Maintenance
 Diesel Exhaust Fluid (DEF) Tank
 Straps 5-3
 Malfunction Indicator Lamp (MIL)
 Symbol..... 3-6

N

Note 1-5
 Notification of High Exhaust System
 Temperature..... 3-8
 Notification Regeneration is
 Required..... 3-9

P

Parked Regeneration 3-13
 Passive Regeneration 3-7

Q

Quick Reference Guide 3-12

R

Regeneration (MANUAL) Switch . 3-15
 Regeneration is Required
 Notification 3-9
 Regeneration Switch
 three-position 3-5
 two-position 3-6

S

Safety
 about this manual 1-3
 caution example 1-5
 general information..... 1-6
 illustrations example 1-6
 introduction 1-3
 note example 1-5
 safety alerts 1-4
 warning example 1-4
 Safety Alerts..... 1-4
 SCR Component Failure – Emergency
 Vehicles..... 3-29

Index

SCR Component Failure –
 Non-Emergency Vehicles 3-24

Selective Catalytic Reduction (SCR)
 System..... 6-7, 3-18
 diesel exhaust fluid (DEF)
 gauge 3-18

Soot 3-4–6-5, 3-9–3-11, 3-17

Specifications
 diesel exhaust fluid (DEF) 6-8

Stop an Automatic or Parked
 Regeneration..... 3-16

Storage
 diesel exhaust fluid..... 6-10

Switches
 regeneration switch
 (three-position) 3-5
 regeneration switch
 (two-position) 3-6

T

Tampering
 Aftertreatment System 6-4
 SCR 3-19, 3-24, 3-29

Three-Position Regeneration
 Switch..... 3-5

Two-Position Regeneration Switch . 3-6

W

Warning 1-4



PACCAR^{Inc}

P.O. Box 1518
Bellevue, WA 98009

Y53-1133-1B1